

Absolute Maximum Ratings

Parameter	Value	Unit
Max DC Voltage Applied	150	V
Max Power Dissipation at 25°C	100	mW
Ambient Temperature	-30 ~ 70	°C



Electrical Characteristics at 25°C

Parameter	Symbol	Value	Unit
Light Resistance at 10Lux	R ₁₀	30 ~ 50	KΩ
Dark Resistance Min.	R _d	20	MΩ
Gamma at (100-10)Lux	γ(100/10)	0.8 ± 0.1	
Spectral Peak		540	nm
Rise Time	T _R	20	ms
Decay Time	T _F	30	ms

Package dimensions (Unit:mm)

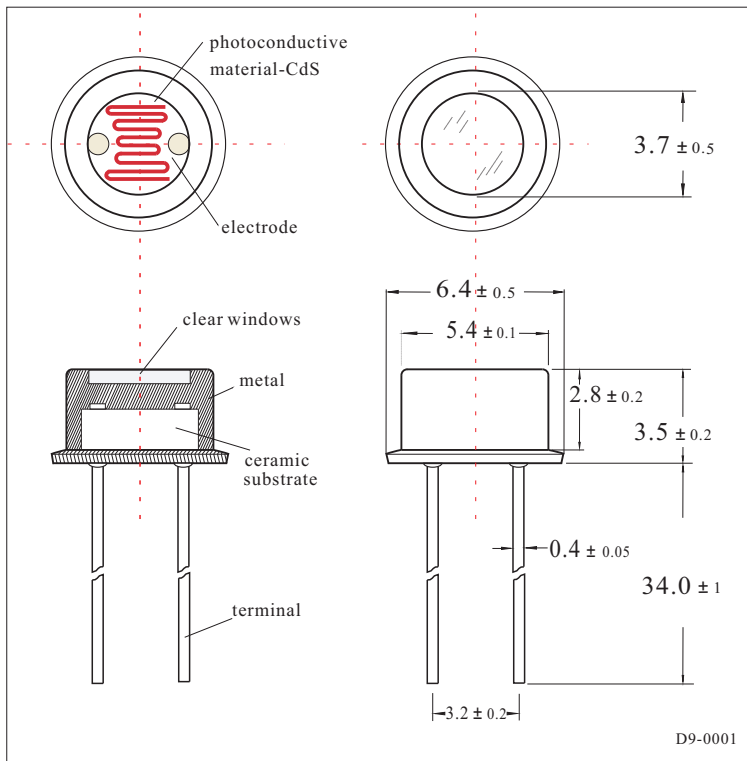

Illuminance vs Photo Resistance

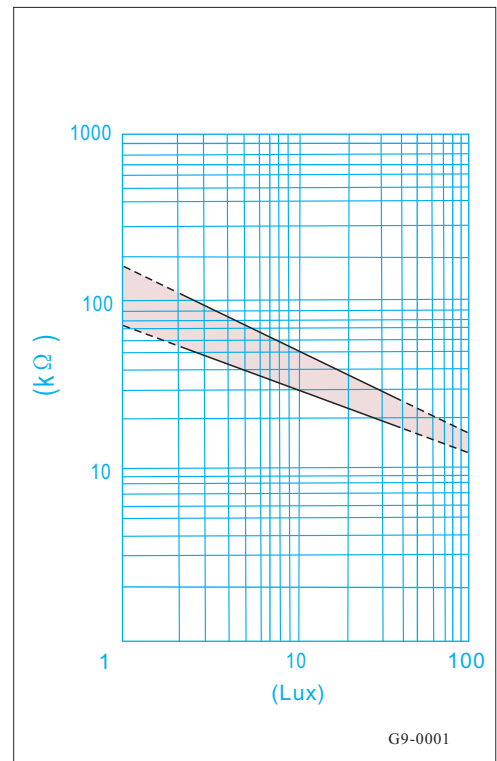

* Photocells are tested at 10 Lux. Other values shown in the tables are for reference only.

* Specification subject to change without notice